

EXTRACTIVE GAS DETECTOR

OPERATION MANUAL

Model PS-7



Contains the PS-7, PS-7 Administrator & Pyrolyzer Manuals

- Store this operation manual in a convenient location, and consult it whenever necessary.
- Operate this unit only after reading and fully understanding the content of this manual.
- This manual uses standard specifications. If your specifications are different, the operation manual that came with your unit takes priority.



740 McArdle Drive, Unit C – Crystal Lake, IL 60014

815-788-5200 Phone 815-788-5300 Fax www.dodtec.com

The name and function of each component

→P 5

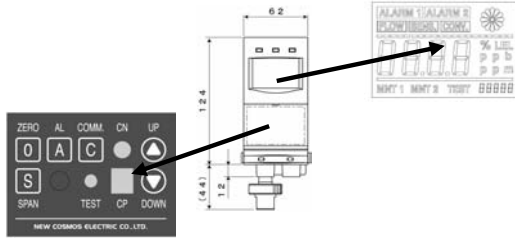

How to install the sensor unit

→P 31

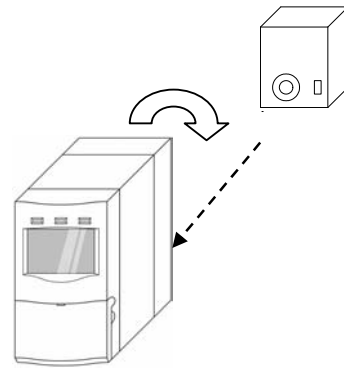

Installation and wiring the base unit

→P 9

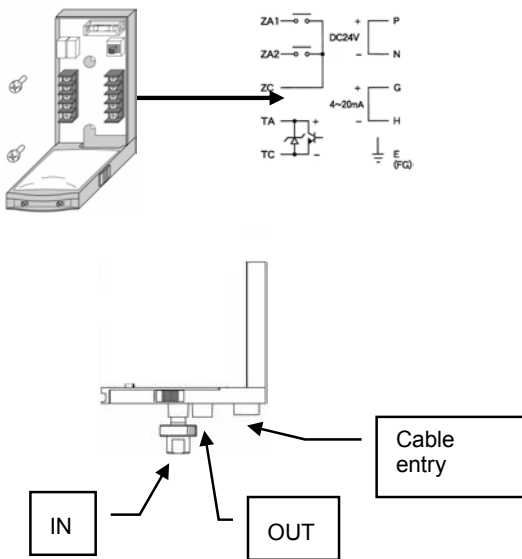

When the gas alarm is activated

→P 23 and P 22

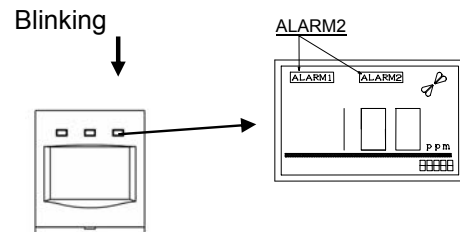

Basic operating instructions

→P 12

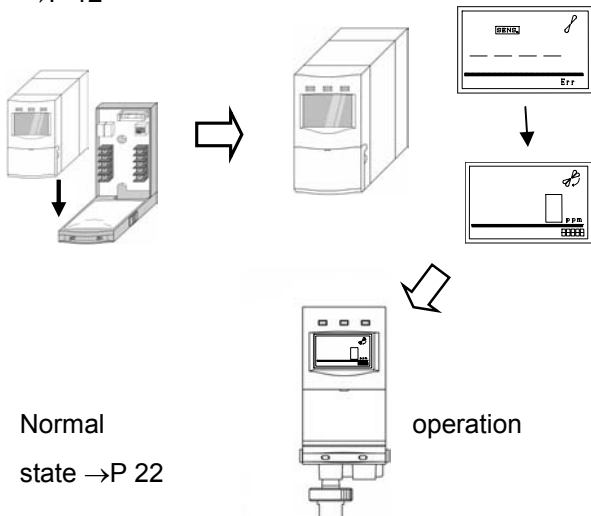

The different types of trouble warnings

→P 25

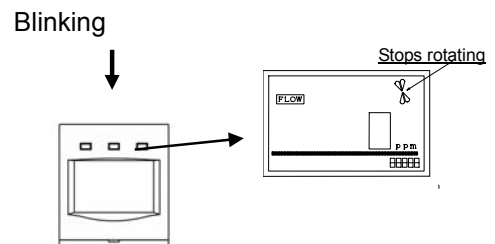

Troubleshooting

→P 36

TABLE OF CONTENTS



1 Introduction.....	1
2 Safety Instructions.....	2
3 Contents of This Package.....	3
4 System Flow Diagram.....	4
5 Description.....	5
5-1 Components on the Main Unit.....	5
5-2 Details of the Key Switch Section.....	7
5-3 Details of the LCD Screen Display.....	8
6 Installation and Wiring.....	9
6-1 Installing the Main Unit.....	10
6-2 Wiring Instructions.....	11
7 Operation.....	12
7-1 Operation Procedures.....	12
7-2 Gas Alarm Operating Instructions.....	23
7-3 Trouble Alarm Operating Instructions.....	25
7-4 Test Mode Settings and Operating Instructions.....	26
7-5 Maintenance Mode Settings and Operating Instructions.....	27
8 Maintenance and Inspection.....	28
9 Replacing Consumables.....	30
9-1 Replacing the Filter Element (FE-1).....	30
9-2 Attach/Replacing the Sensor Unit.....	31
9-3 Replacing the Sampling Unit.....	34
10 Troubleshooting.....	36
11 Specifications.....	37
12 Warranty.....	38
13 Detection Principles.....	38
13-1 Electrochemical Sensor.....	38
13-2 Hot-wire Semiconductor Sensor.....	39
13-3 Galvanic Cell Sensor.....	40
14 Glossary.....	41

1 Introduction

- Thank you for purchasing the extractive COSMOS Gas Detector Model PS-7.
- This Gas Detector is designed to detect the leakage of toxic and combustible gases. It is designed to display the concentration level of detected gases on the main unit and output that information externally as an analog signal. When a preset warning level of gas is detected, the warning lamp (ALARM lamp) on the main unit starts to blink, the external contact output is activated, and the amount of leaking gas is monitored.
- The sensor unit and sampling unit used in the Gas Detector can be replaced without the use of tools. Regular replacement of these components eliminates the need to perform calibration on-site.
- To ensure correct operation, read this manual carefully before attempting to install or operate the Gas Detector.

Explanation of Symbols

This manual uses the following symbols. Their meanings must be understood and observed to ensure safe operation of the unit.

 Danger:	Indicates an impending hazardous situation that, if not avoided, will result in serious injury or death.
 Warning:	Indicates a potentially hazardous situation that, if not avoided, could result in serious injury or death.
 Caution:	Indicates a potentially hazardous situation that, if not avoided, could result in minor injury or physical damage.
Note	Indicates operational advice and/or instructions.

2 Safety Instructions

- Read and understand the following information to ensure that the Gas Detector is used correctly.
- The Gas Detector must always be used in accordance with relevant laws and regulations, and all wiring, installation, and other work associated with the Gas Detector must be performed by qualified personnel.

Warning

- When the Gas Detector detects a gas leak, carry out the procedures stipulated by your company in response to gas leaks.
- The Gas Detector must be grounded to prevent electric shock.
- The Gas Detector is not explosion-proof. It must be installed in a safe location.

Caution

- Do not disassemble or modify the unit, or change its construction or circuitry in any way. Doing so may impair the unit's performance.
- The Gas Detector is not drip-proof and must be installed in a location free from spattering water.
- The unit must be used in accordance with prescribed laws and regulations.
- Please turn the power switch located on the front of the base unit OFF when attaching or removing the main unit. If this is done with the switch left ON, the unit may become damaged, or give false alarms.

3 Contents of This Package

- The following components are included with the standard Gas Detector unit. Ensure that all components are present before attempting to use the unit. Every effort is made to ensure that the unit is packed correctly, but if any components are damaged or missing, contact your local authorized distributor.

Description	Quantity
PS-7 Gas Detector	1
Male connector (R1/4- ø6)	2
Filter elements (FE-1, 12 pcs.) (For MF-50 Filter Unit)	1
Fuse (0.5 A)	1
Mounting screws (M4 × 8)	2
Stick for Test	2 [*] 1
Operation Manual	1*2
Operation Manual	1*2

*1 2 sticks are provided with each system.

Note: 1)The sensor unit is not bundled with the Gas Detector, and must be purchased separately.
2)When it is with DeviceNet unit, the contents are as described in the DeviceNet Unit Instruction manual

Options

Option	Quantity
Filter (MF-51) ^{*3}	Ordered quantity
Gas collector (PF-D1)	Ordered quantity

*3 Recommended for use with highly adsorbent gases
(HCl, Cl₂, NH₃, etc.) other than HF and F₂.

4 System Flow Diagram

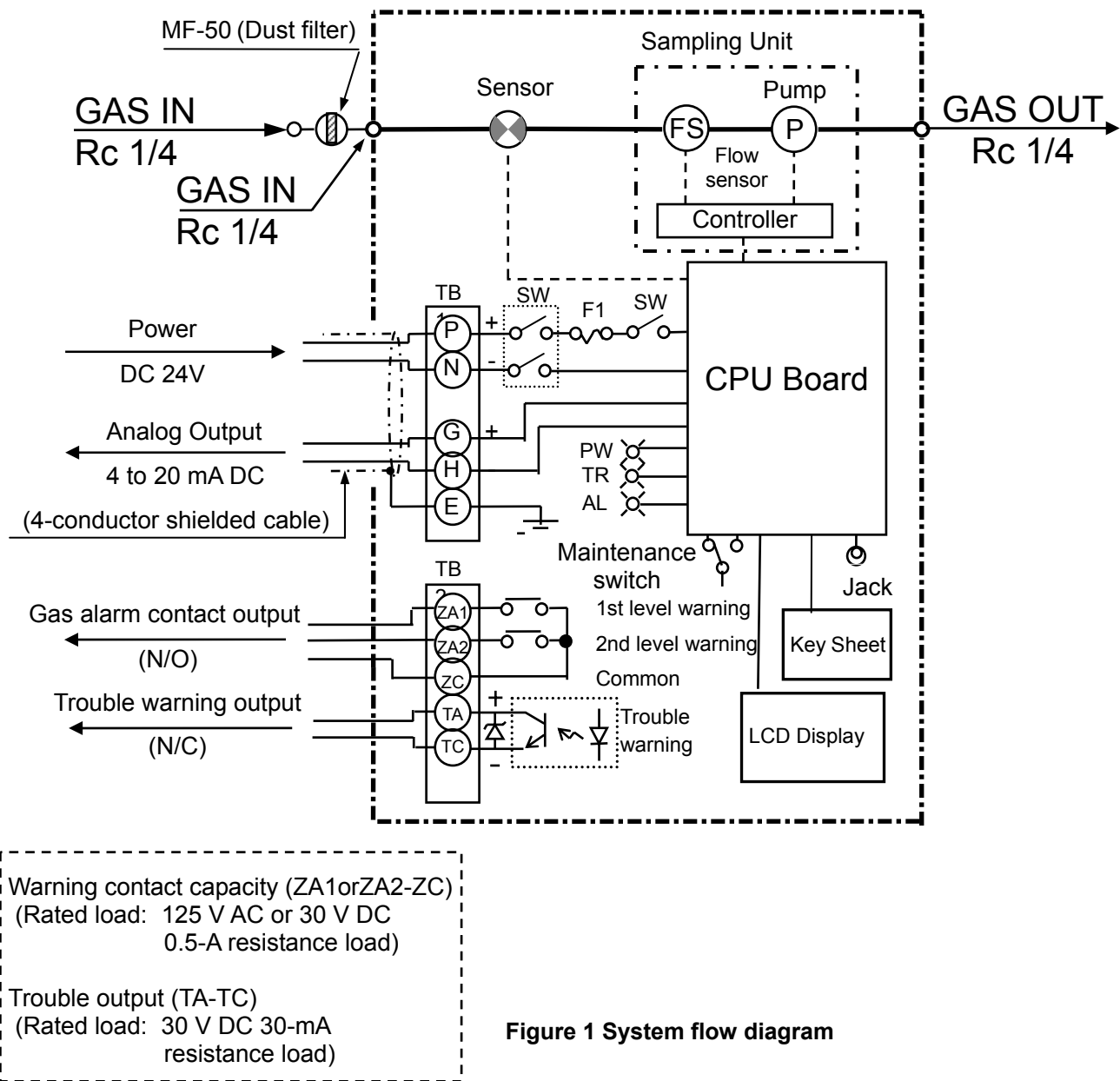

Figure 1 System flow diagram

⚠ Warning

Pay special attention to the polarity of the trouble warning output. As the circuit protection diodes are internalized, if the polarity is reversed, the trouble warning signal will not be output.

⚠ Caution

The analog output source is not insulated from the power source. In case it is used in combination with other types of devices, the analog signal must be isolated from flowing into the power sources of the other devices.

5 Description

5-1 Components on the Main Unit

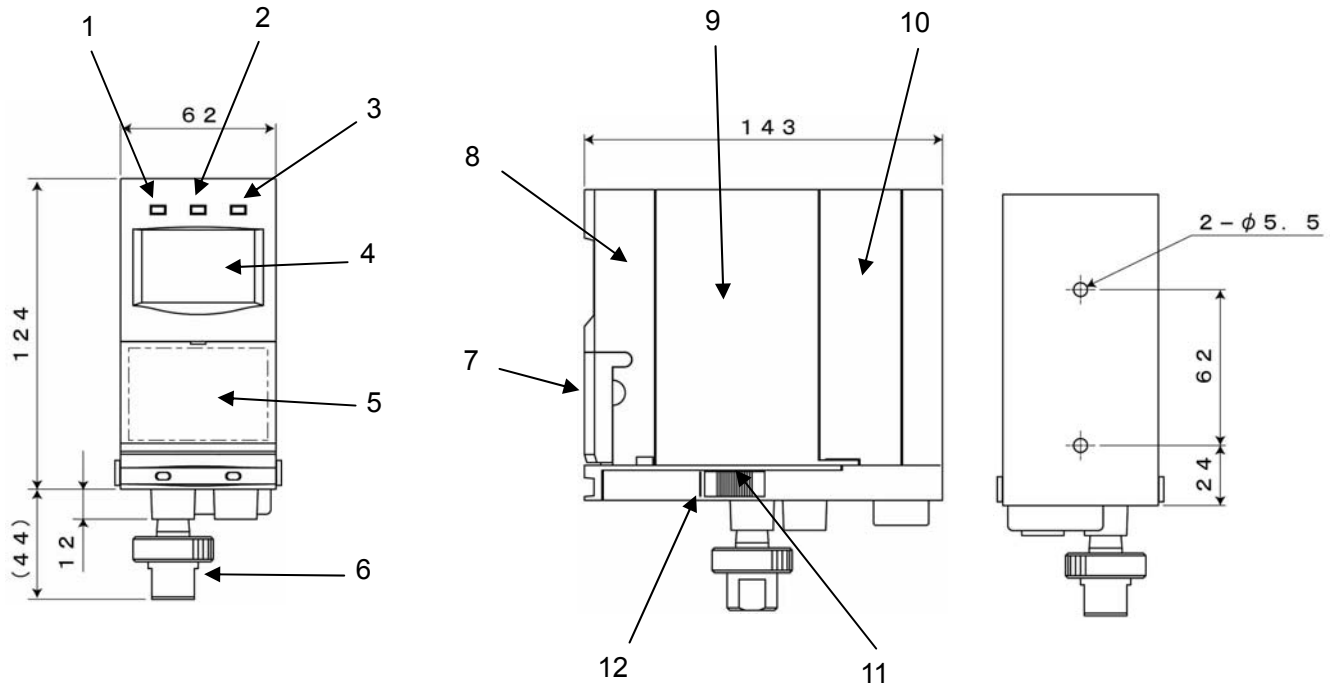

No.	Description	Function
1	POWER lamp	(Green) Power lamp. Illuminates during regular monitoring operations.
2	TROUBLE lamp	(Yellow) The lamp blinks when trouble occurs.
3	ALARM lamp	(Red) The lamp blinks when the concentration level of detected gas exceeds that of the preset alarm level.
4	LCD display	Warning displays, detected gas levels, bar graphs of gas levels, trouble states, maintenance modes, test mode, flow sign are all shown on the LCD display.
5	Key switches (inside)	Switches to carry out the various settings.
6	Filter unit (MF-50)	Incorporates a filter element (FE-1) that prevents dust from entering the gas inlet and tubes leading to the sensor.
7	Operation section cover	Lift up gently to use key switches.
8	Front panel	Contains the main board.
9	Sampling unit	The pump is contained inside the sampling unit.
10	Main body cover	The cover protecting the sensor unit.
11	Latches	Latches to attach the main unit onto the base unit.
12	Locked/unlocked line	A line (mark) to show the return position of the latch.

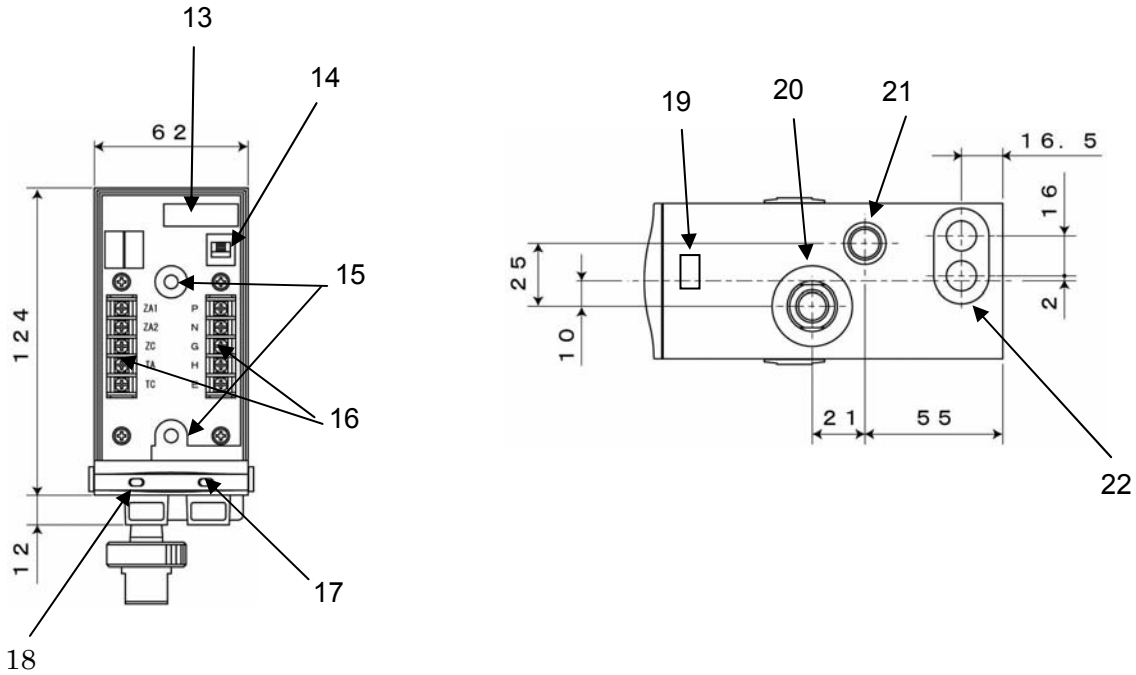

Figure 3 Dimension & description (Units: mm)

No.	Description	Function
13	Fuse	125 V, 0.5 A
14	Base unit power switch	The power switch for the base unit.
15	Mounting holes	Screw holes ($\varnothing 5.5$) for wall mounting.
16	Terminal strip	Used to connect external wiring.
17	Main unit power switch	The power switch for the main unit.
18	Maintenance switch	A switch that is set to regular, maintenance mode 1 (MNT1) or maintenance mode 2 (MNT2).
19	Connector for the pyrolyzer	A connector to provide power to the pyrolyzer when one is being used. (CDP-7 type).
20	Gas inlet	Aspiration inlet for sampled gas. A filter unit (MF-50) is attached.
21	Gas outlet	Exhaust outlet for sampled gas.
22	Cable entry	A hole for incoming cables.

5-2 Details of the Key Switch Section

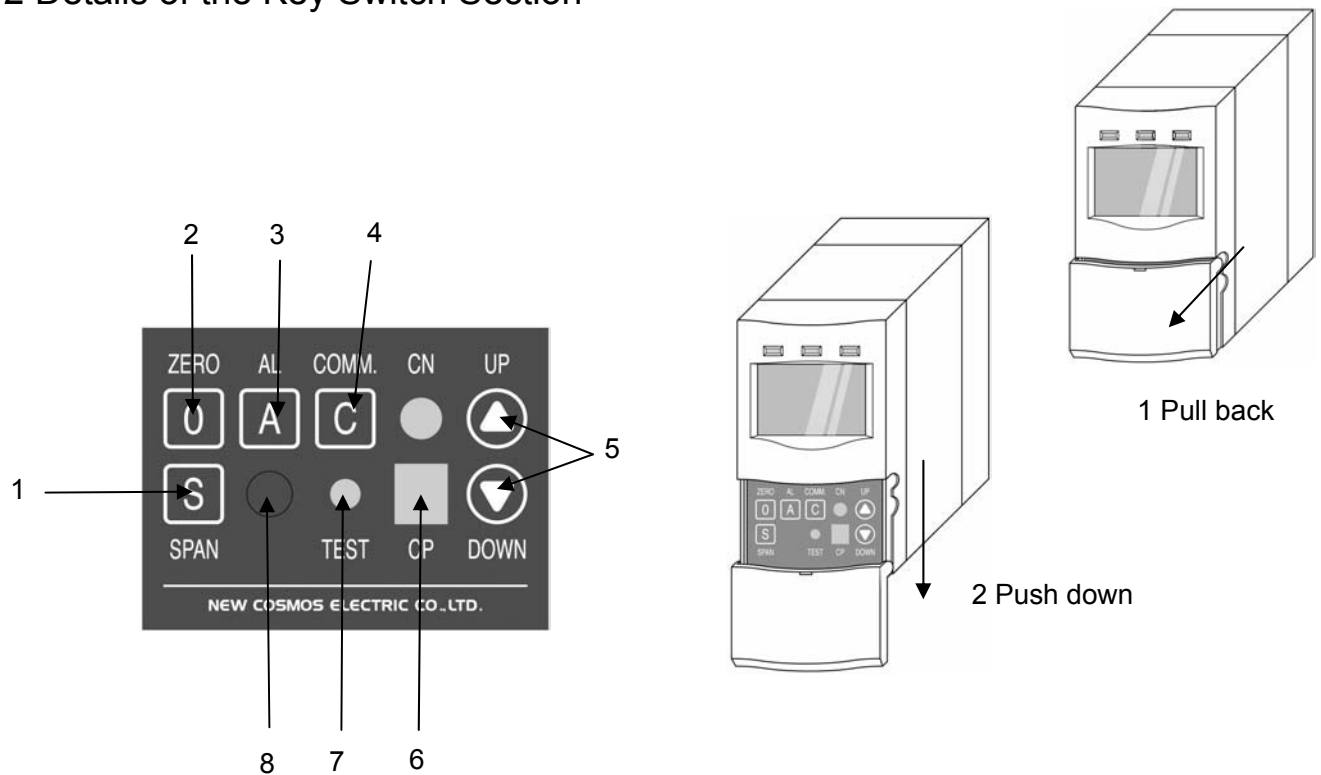

Figure 4 Names and functions of key switches

No.	Description	Display	Function
1	Span adjustment switch	SPAN	To carry out 21vol% adjustments. (For the COS-7 oxygen sensor unit.)
2	Zeroing switch	ZERO	To carry out zeroing. (For the CHS-7 flammable gas sensor unit or CDS-7 toxic gas sensor unit.)
3	Alarm point set switch	AL	Used to check the values of various alarm settings.
4	Communications switch	COMM.	Sends sensor unit information to the main unit after initial start-up, etc.
5	Up/down switch	UP DOWN	Used to change the values of the test output, etc.
6	Connector to check analog output	CP	A connector employed especially to check the analog output from the main unit (4- 20 mA).
7	Test switch	TEST	Used to set to test mode.
8	Special command switch	(None)	Used to change the values of various settings. (For administrative use.)

5-3 Details of the LCD Screen Display

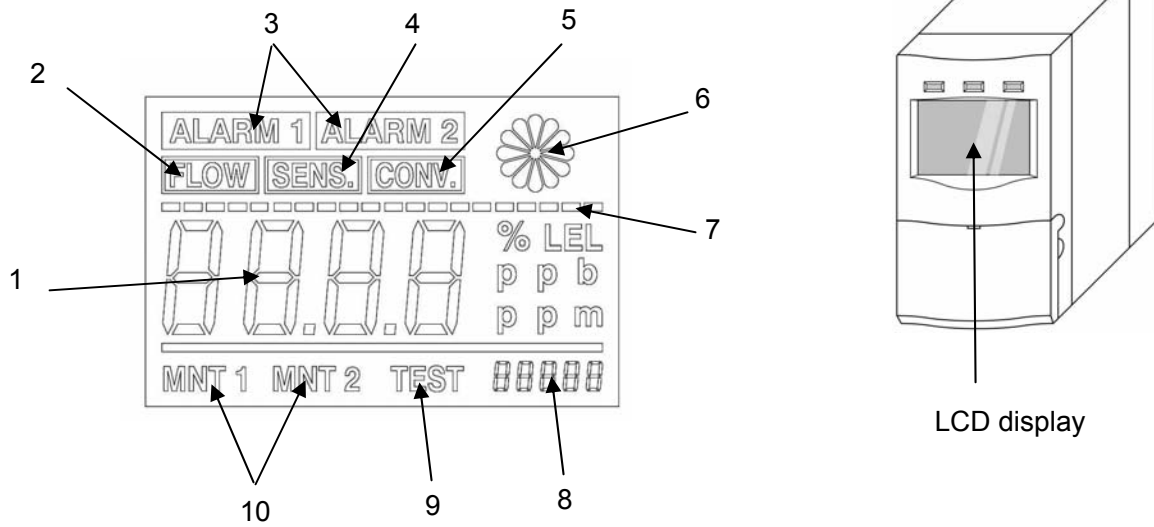

Figure 5 Parts of the LCD screen display

No.	Meaning
1	Shows the detected gas concentration (with units).
2	Lights when the flow rate is decreasing. (Also see no. 6 below.)
3	These light when the detected gas concentration exceeds that of the preset alarm level.
4	Lights on when there is sensor trouble, or when a sensor is inserted incorrectly.
5	Lights on when the pyrolyzer is disconnected.
6	Shows the flow rate of the sampling gas. Fast rotating display: When flowing at normal rate (0.5 L/min). Slowly rotating display: (Showing that it is clogged) When the load on the pipe is high. No rotation: (Warning that the flow rate is decreasing) When the flow rate has decreased.
7	Bar graph of gas concentration. One division is 5% of a full scale value. When the bar extends to the far right, it is at full scale.
8	Shows the values of various settings. (For administrative use.)
9	Lights while in test mode.
10	Lights while in either maintenance mode 1 (MNT1) or mode 2 (MNT2).

6 Installation and Wiring

Warning

- The Gas Detector is not explosion-proof. It must be installed in a safe location.
- When detecting highly adsorbent gases such as HF and F₂, install the Gas Detector with the filter element (FE-1) removed from the filter unit (MF-50). (Refer to 9-1 *Replacing the Filter Element*.)
- For the gas sampling pipe, use a Teflon conduit of $\varnothing 6/4$ having a maximum length of 20 meters. Note, however, that for highly absorbent gases, such as HF, F₂, HCl, Cl₂ and NH₃, the length of the conduit should be no more than five meters.

Caution

- The Gas Detector should be installed in a location free from shock and vibration, and away from sources of high frequencies or magnetism.
- Do not use the gas collector hood when detecting gas concentrations in narrow spaces such as ducts.
- Do not install the Gas Detector in locations where the temperature may exceed 40°C or dew condensation or sudden temperature fluctuations may occur.
- The Gas Detector is not drip-proof.
- The pressure difference between the gas inlet/exhaust ports and the ambient atmosphere must be within ± 1 kPa. The pressure difference between the inlet port and exhaust port must be such that the inlet port is a negative pressure of 1 kPa or less.
- Install the Gas Detector vertically. (Inlet port and exhaust port must be in downward direction.)
- Locate the detector tip (the tip of the gas sampling pipe) to be appropriate for the specific gravity of the gas to be detected. It must also be placed in a location where the target gases are likely to accumulate.

Type of gas	Installation height
Heavier than air	Not more than 30 cm above floor level
Equivalent to air	75 to 150 cm above floor level
Lighter than air	Near the ceiling

6-1 Installing the Main Unit

- (1) Determine the installation point and attach the base unit using two M4 × 8 screws.
- (2) Run a cable through the cable entry (the cutout hole near the bottom of the base unit) and connect to the terminal board. (Refer to 6-2 *Wiring Instructions*.)
- (3) To attach the sensor unit, refer to 9-2 *Attach/Replacing the Sensor Unit*. To attach it after attachment of the base unit, proceed to step 4.
- (4) Remove the protective seal before attaching the main unit.

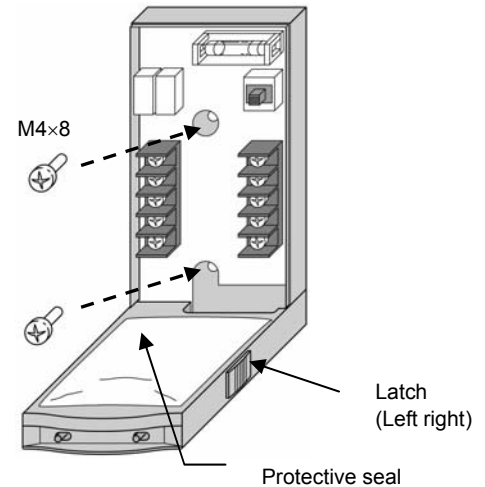

- (5) Pull back the latches on both the left and right sides of the bottom of the base unit, and attach the main unit inserting from the top side first.

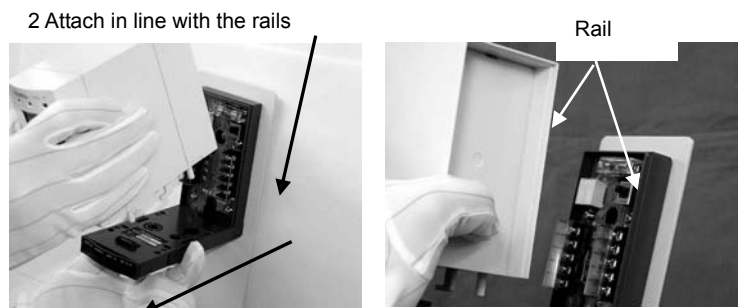

- (6) Push both the latches on the left and right hand sides of the base unit back in until the locked/unlocked line can be seen

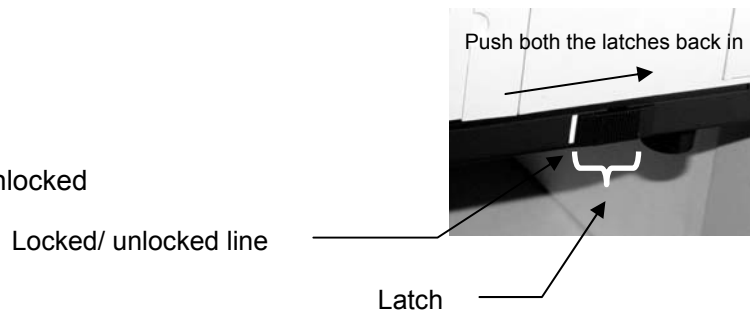

Warning

Be sure to push the latches back as far as they will go. If the latches are not back behind the locked/unlocked line, normal gas detection will not be performed.

Note

- The protection seal on the base unit is to protect the connector and internal piping when attaching the base unit. This seal is not necessary after the main unit is attached. Please dispose of it properly in accordance with company disposal regulations.
- If multiple units are to be mounted in a row, ensure that there is sufficient space between each unit (at least 3 cm on either side is recommended) to allow the main unit to be removed and reattached.

6-2 Wiring Instructions

Terminal Board	Sign	Polarity	Function
TB1	P	+	Power supply (24 V DC)
	N	-	
	G	+	
	H	-	Gas concentration output (4-20 mA DC)
	E		Ground
TB2	ZA1		Gas alarm contact output (1 st level) (no voltage contact 1a) Rated load: 125 V AC or 30 V DC, 0.5-A resistance load
	ZA2		Gas alarm contact output (2 nd level) (no voltage contact 1a) Rated load: 125 V AC or 30 V DC, 0.5-A resistance load
	ZC		ZA1, ZA2 common
	TA	+	Trouble alarm (Open collector: N/C) Rated load: 30 V DC, 30-mA resistance load
	TC	-	Trouble alarm common

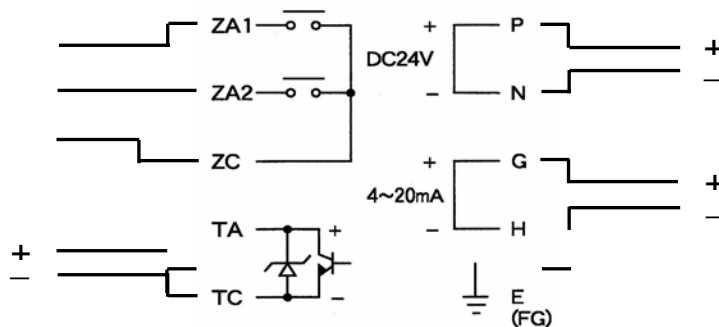

Figure 6 Terminal strip

⚠ Warning

- Be especially careful regarding the polarity of the trouble alarm (TA: plus, TC: minus.) as the circuit protection diodes are internalized, if the polarity is reversed, the trouble warning signal will not be output.
- To avoid electric shock, always disconnect the power supply before performing any wiring operations.
- Ensure that the unit is properly grounded.

⚠ Caution

- Do not lay cables near sources of electrical noise, such as high-capacity transformers, motors or power supplies.
- Ensure that the cables on the external device side and the gas detector side are correctly connected.

7 Operation

7-1 Operation Procedures

Carry out operations in the following manner. Refer to the items inside each box for more detailed instructions (listed from the next page)

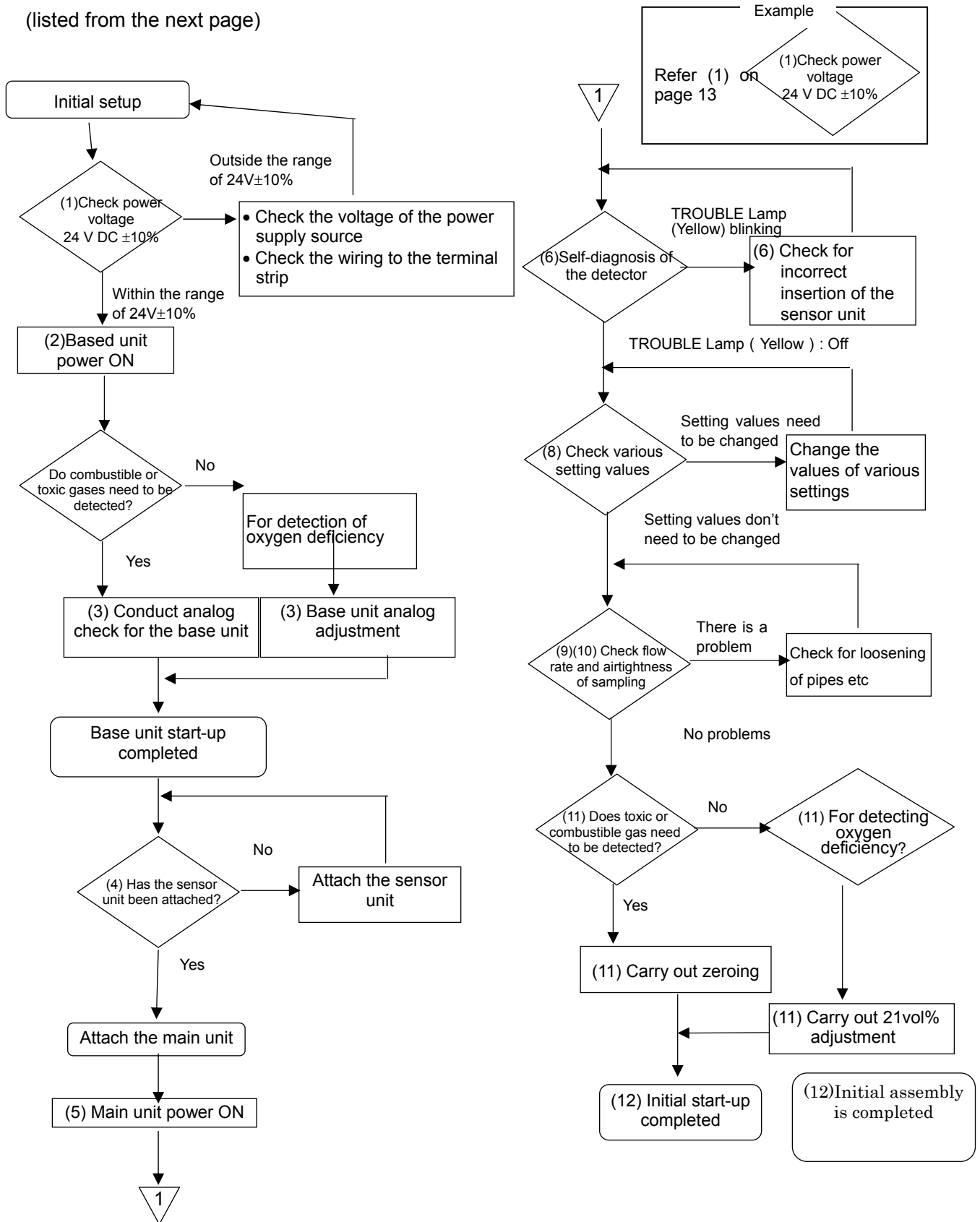

7-1 Operation Procedures (Contd.)

 Warning

- Verify that the power supply voltage is 24 V DC $\pm 10\%$.
- Before operating the Gas Detector, verify that the sensor unit correctly displays the type of gas to be detected and the full-scale value.

 Caution

- Before turning the power ON, check that all connections are correct. Refer to 6-2 *Wiring Instructions* and the separate Delivery Specifications, if available.

Proceed with operation in the following manner.

- (1) Verify that the power supply voltage (the voltage between the P and N of the terminal block) is 24 V DC $\pm 10\%$.
- (2) Switch the base unit power ON.

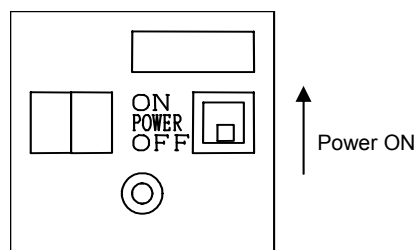

(3) Analog adjustment in maintenance mode 2

The analog output of the main unit changes when the maintenance switch is set to 2.

Adjustment should be carried out based on the following instructions as the analog output also differs depending on the sensor unit being used. For details regarding maintenance modes, refer to 7-5 *Maintenance Mode Settings and Operating Instructions*.

Toxic gas sensor unit : CDS-7
 Combustible gas sensor unit : CHS-7
 Oxygen sensor unit : COS-7
 (Value when at full scale 25vol%)

Oxygen sensor unit : COS-7
 (Value when at full scale 50vol%)
***MUST BE ADJUSTED**

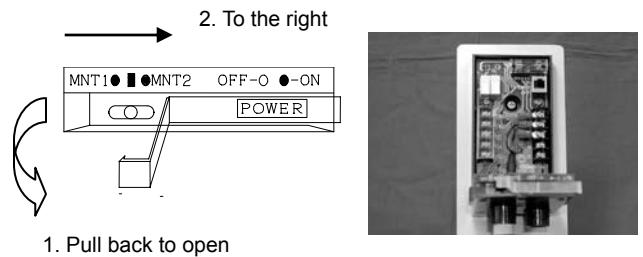
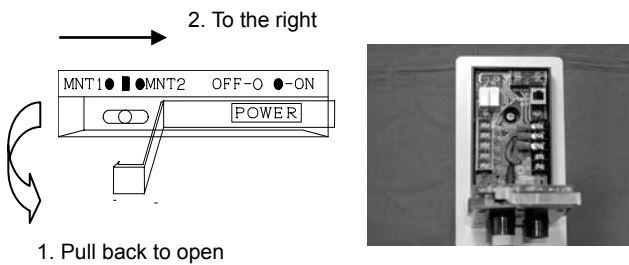

To set to maintenance mode 2 (MNT2)

To set to maintenance mode 2 (MNT2)



Analog adjustment volume for maintenance mode 2

Analog adjustment volume for maintenance mode 2

The tester tests the current range
 G= plus
 H= minus



The tester tests the current range
 G= plus
 H= minus



Measure the analog output (current) of “G” and “H” on the terminal board TB1 using a tester, etc.
 If it falls within the range shown below, go on to the next step.
 If it is not within the range shown below, use the analog adjustment volume for maintenance mode 2 to bring it into this range.

Measure the analog output (current) of “G” and “H” on the terminal board TB1 using a tester, etc.
 Adjust it to within the range of 10.64 to 10.80 mA by using analog adjustment volume for maintenance mode 2.

Model of sensor unit	Adjustment range
CDS-7	3.92 to 4.08 mA
CHS-7	3.92 to 4.08 mA
COS-7	17.32 to 17.48 mA

For toxic gas sensor unit: CDS-7, or
combustible gas sensor unit : CHS-7

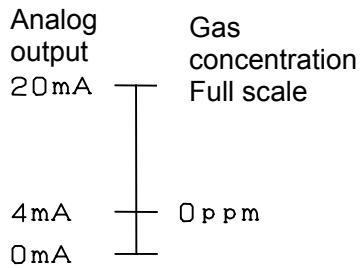

Oxygen sensor unit : COS-7
(When full scale value is 25vol%)

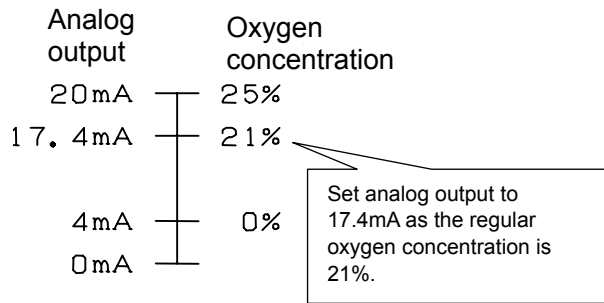

2. To the center

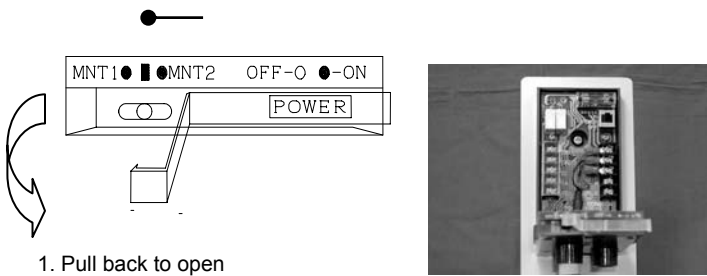

Set to normal mode (center)

Oxygen sensor unit : COS-7
(When full scale value is 50vol%)

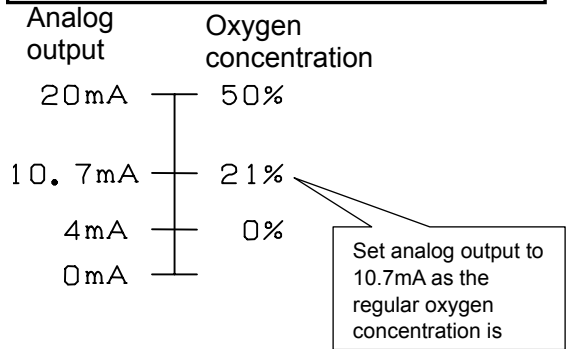

2. To the center

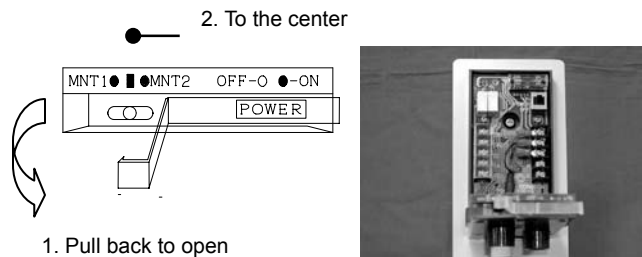

Set to normal mode (center)

- (4) If the sensor unit is not attached, refer to 9-2 *Attach/Replacing the Sensor Unit*, and attach the sensor unit.
- (5) Switch the main unit power ON

*Refer to 6-1 *Installing the Main Unit*.

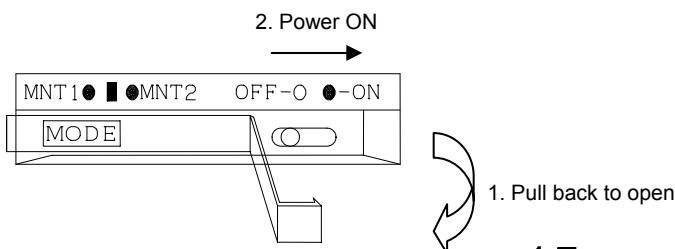

(6) Begin self-diagnosis after the front lamp and the LCD screen have been on for over one second.

When using the main detector for the first time, or when a new sensor unit with different settings (sensor units for which the target gases and full scale values, etc., are different) has been attached:

The TROUBLE lamp (Yellow) will blink.

Also **SENS.** will be displayed at the top of the LCD screen and Err on the bottom right.

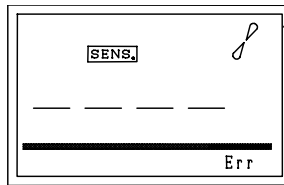

The TROUBLE lamp (Yellow) will blink



Open the cover on the operation section of the main body and hold down the key switch "COMM" for over one second.

→To (7)

When the sensor unit has been replaced, or when a sensor unit with the same settings (sensor units for which the target gases and full scale values etc are the same) has been attached:

→To (7)

(7) When "Good" is displayed at the bottom right of the LCD screen, it will go into initial power delay mode (POWER lamp blinks) for 30 seconds. It will then return to normal operation state, and the POWER lamp will come on. The detected gas concentration will be displayed in the middle of the screen.

POWER lamp (Green)
Blinks (30 secs)→On



(8) Check the various setting values

The values of the various settings can be checked by pressing the up/ down switch, “△” or “▽” on the main unit.
The setting values are displayed in the bottom right hand corner of the LCD screen.
They may sometimes difficult to distinguish due to the types of alphabet letters used.

LCD Screen Display	The function to be set	Remarks	Default value	
			Toxic : CDS-7 Combustible: CHS-7	Oxygen: COS-7
d1 **	Time delay1	Time delay (secs.) of the gas alarm contact (1 st level)	d1 0	d1 0
d2 **	Time delay2	Time delay (secs.) of the gas alarm contact (2nd level)	d2 0	d2 0
az	Analog output (base)	(*For our maintenance purposes only)	-	-
as	Analog output (span)	(*For our maintenance purposes only)	-	-
zs *	Zero suppression, or 21vol% suppression	Displays the percentage of the full scale value (rounded to the percent)	zs 5	zs 2
H-H L-L H-L	Alarm mode	1st: Upper limit, 2nd: upper limit warning 1st: Lower limit, 2nd: lower limit warning 1st: Upper limit, 2nd: lower limit warning	H-H	L-L
Con *	Pyrolyzer failure alarm.	0 : Off 1: On	Con 0	Con 0
CG **	Calibrated gas concentration	(*For our maintenance purposes)	CG 40	CG 84
nEt *	The existence of DeviceNet unit	0 : Non-existent 1: Existent	nEt 0	nEt 0
F ***	Display of f value	(*For our maintenance purposes)	-	-
FL ***	Displays rate of flow	Shows the current rate of flow (mL/min)	-	-
P ***	Sensor unit output	(*For our maintenance purposes)	-	-
At *	Auto 21vol% adjustment	0 : No 1: Yes		At 1

The values of alarm settings can be checked by pressing the alarm setting switch “AL”.

“AL1 displayed” → “AL2 displayed” → “Normal” → “AL1 displayed” → (Repeat)

The percentage of the full scale value for the current alarm values will be displayed in the bottom right hand corner of the LCD screen (in units of 1%), and the alarm set value at the current gas concentration is displayed in the middle of the screen.

LCD Display Screen	Default value		Explanation of the default value
A1 **	Toxic: CDS-7 Combustible: CHS-7	A1 10	10% of F.S.
	Oxygen: COS-7	A1 72	72% of F.S.
A2 **	Toxic: CDS-7 Combustible: CHS-7	A2 20	20% F.S.
	Oxygen: COS-7	A2 76	76% of F.S.

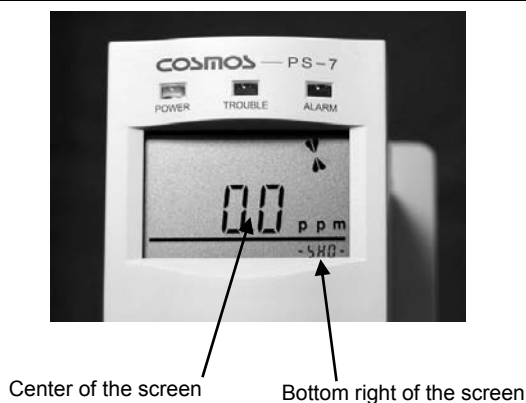
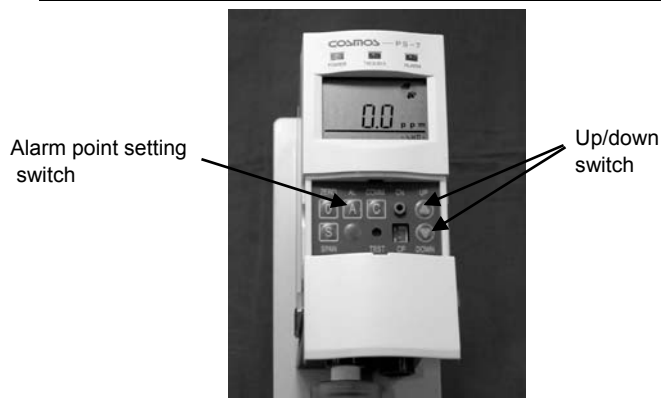

Refer to the separate PS-7 Operation Instructions for Administrators to change the values of various settings.

(9) Verifying the sampling flow rate (Check flow rate)

Check to see that the flow rotation rate is high, and the TROUBLE lamp (yellow) is off.

If the flow rotation is high, then it is flowing at the designated rate (0.5 L/min).

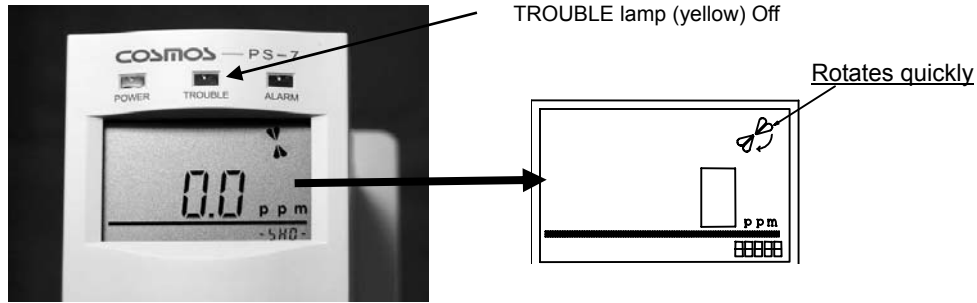

Note

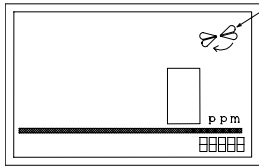
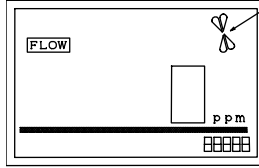
<p>-Clogged display-</p>  <p>Rotates slowly</p> <ul style="list-style-type: none">• Slowly rotating flow rate. <p>A "clogged display" will be shown when the load on the pipes is high. This could mean "the pipes are clogged," "the filter is clogged," or "the load is too high," and monitoring of gas concentration will continue even when the "clogged display" is shown.</p>	<p>-Warning that flow rate is decreasing-</p>  <p>Stops rotating</p> <ul style="list-style-type: none">• No rotation.• FLOW is displayed on the LCD screen.• TROUBLE lamp (yellow) blinks.• Trouble warning is activated. <p>When the flow is not at the designated rate, a warning that the flow rate is decreasing is output.</p>
---	---

(10) Verifying airtight seal

Disconnect the gas sampling pipe from the gas inlet and block the inlet with a finger completely.

The flow rotation rate will then slow. By keeping the inlet blocked off, it will eventually stop, and then check to make sure the TROUBLE lamp (yellow) is blinking. (The warning that the flow rate is decreasing is generally set to a delay time of 10 seconds.) **FLOW** will be displayed on the LCD screen.

If the flow rate rotation stops, and the TROUBLE lamp (yellow) does not come on, please check to ensure the sensor unit is properly attached to the main unit. (Refer to 9-2 Attach/Replacing the sensor unit). Also, check to ensure that the latches at the bottom of the base unit are correctly locked back behind the locked/ unlocked line.



Block the inlet

When the pipes have been returned to normal, recheck to see that the flow rotation rate is high.

(11) Adjusting the Zero/21 vol% setting (Zeroing for the CDS-7, CHS-7, and 21vol% adjustment for the COS-7)

After power is applied to the main unit, and the appropriate time period has passed (depending on the type of sensor unit), press the appropriate key switch from the below table. Then, be sure to do a readjustment to increase precision.

Sensor Unit	Initial adjustment	Readjustment	Zero / 21ol% adjustment key switch
Toxic gas sensor unit CDS-7	30 minutes after power ON	24 hours after power ON	Maintenance mode1 or 2 + ZERO switch ^{*1}
Oxygen sensor unit COS-7			Maintenance mode1 or 2 + SPAN switch ^{*2}
Combustible gas sensor unit CHS-7	1 day after power ON	7 days after power ON	Maintenance mode1 or 2 + ZERO switch ^{*1}

Note

Factors such as the atmosphere of the installation location may cause the Zero/21 vol% setting to take longer to stabilize (the time until re-adjustment) than the time indicated in the above table.

-Zeroing-

For the:

Toxic gas sensor unit: CDS-7

Combustible gas sensor unit: CHS-7

-21vol% Adjustment-

For the:

Oxygen sensor unit: COS-7

1. Set to maintenance mode (MNT1 or MNT2).

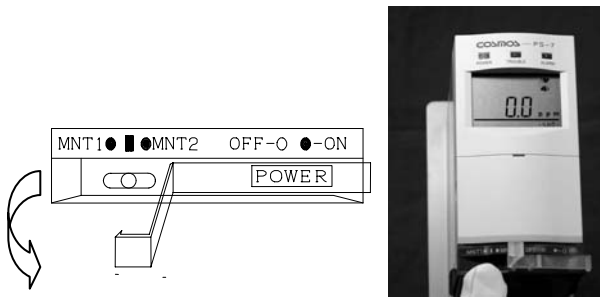

Pull back to open

Left: Maintenance1 (MNT1)
Center: Normal mode
Right: Maintenance 2 (MNT2)

1. Set to maintenance mode (MNT1 or MNT2).

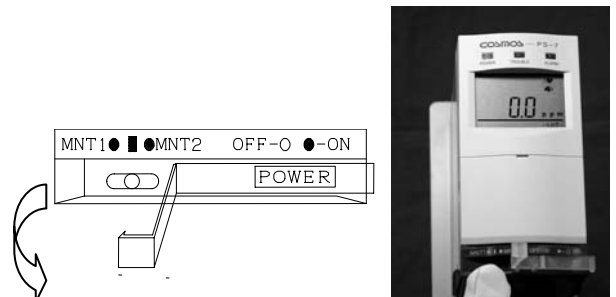

Pull back to open

Left: Maintenance1 (MNT1)
Center: Normal mode
Right: Maintenance 2 (MNT2)

*For details regarding maintenance modes, refer to 7-5 Maintenance Mode Settings and Operating

*For details regarding maintenance modes, refer to 7-5 Maintenance Mode Settings and

For the:

Toxic gas sensor unit: CDS-7

Combustible gas sensor unit: CHS-7

2. Hold down the ZERO Key for over a second.
It is complete when the POWER lamp (green) blinks once.

It is complete when the POWER lamp (green) blinks once.



3. Set back to normal mode (Center)

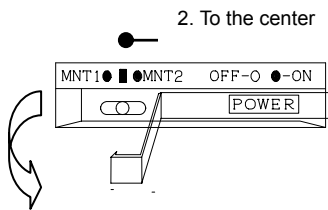

1. Pull back to open



* Be sure to do a readjustment after the appropriate time period has passed to increase precision.

Poisonous gas sensor unit: After 24 hours

Flammable gas sensor unit: After 7 days

For the:

Oxygen sensor unit: COS-7

2. Hold down the SPAN Key for over a second.
It is complete when the POWER lamp (green) blinks once.

It is complete when the POWER lamp (green) blinks once.



3. Set back to normal mode (Center)

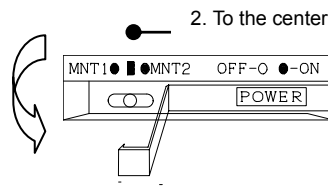

1. Pull back to open



* Be sure to do a readjustment after the appropriate time period has passed to increase precision.

Oxygen sensor unit: After 24 hours

Warning

Zeroing and 21vol% adjustment must be carried out in a clean environment. If they are done in a gas-filled environment, the correct level of gas concentration detected will not be given.

(12) Affix the seal showing target gases to be detected in a clearly visible place on the front of the main body.

–Normal operation state–

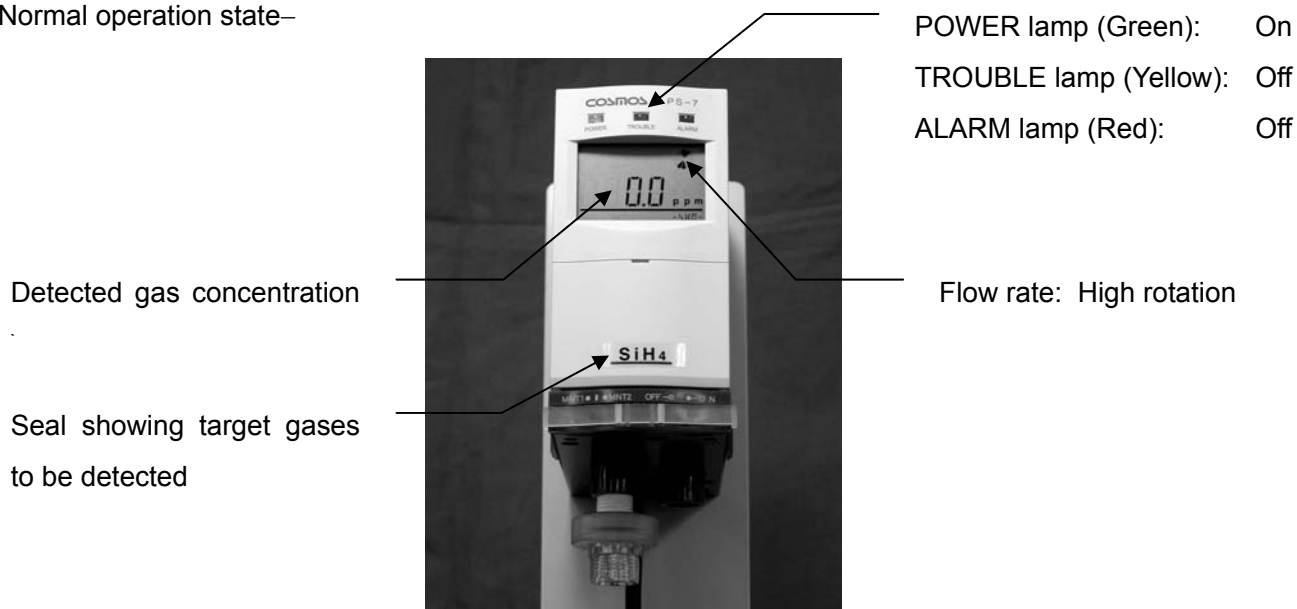

Figure 7 Normal operation state

	Normal	Trouble	Gas alarm (1 st stage)	Gas alarm (2 nd stage)
LED	Green light 	Yellow blink 	Red blink 	Red blink
LCD screen		FLOW SENS CONV	ALARM1	ALARM1 ALARM2
Alarm contact (ZA1) 	OFF	OFF	<u>ON</u>	<u>ON</u>
Alarm contact (ZA2) 	OFF	OFF	OFF	<u>ON</u>
Trouble alarm (TA) 	ON	<u>OFF</u>	ON	ON

7-2 Gas Alarm Operating Instructions

When the concentration level of detected gas exceeds that of the preset alarm level, the alarm contacts are activated after a set time delay, the ALARM lamp (red) blinks, and **ALARM1** or **ALARM2** is displayed on the LCD screen.

* During the alarm time delay, **ALARM1** or **ALARM2** blinks on the LCD screen, but the alarm contacts are not activated, and the ALARM lamp (red) does not blink.

When the concentration of detected gas drops back below the preset alarm level, it will automatically return to normal.



The ALARM lamp (red) will blink with the gas alarm (1st level), or gas alarm (2nd level)

–Gas alarm (1st level)–

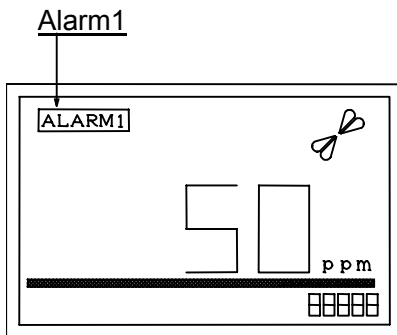

–Gas alarm (2nd level)–

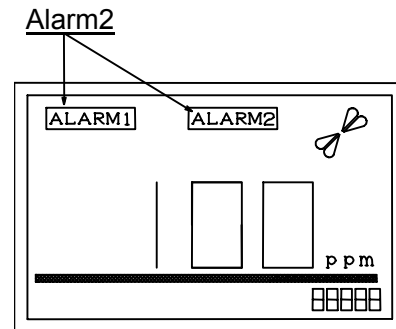

※ When the 2nd level gas alarm is activated, both the **ALARM1** and **ALARM2** will turn on.

○ : On △ : Blinking ● : Off

	Alarm level	LCD Screen	POWER Lamp (Green)	TROUBLE Lamp (Yellow)	ALARM Lamp (Red)	Remarks
1	Gas alarm (1 st level)	ALARM 1	○	●	△	
2	Gas alarm (2 nd level)	ALARM 1, ALARM 2	○	●	△	

Note

The relationship between 1st level and 2nd level alarm values of each alarm mode is as follows:

H – H mode (1st level: Upper limit, 2nd level: Upper limit)

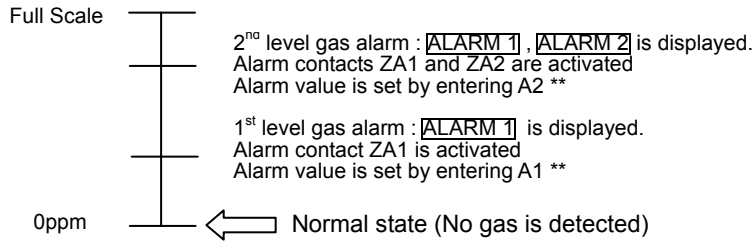

L – L mode (1st level: Lower limit, 2nd level: Lower limit)

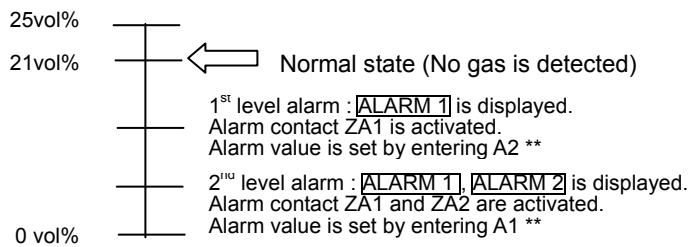

H – L mode (Upper limit, Lower limit)

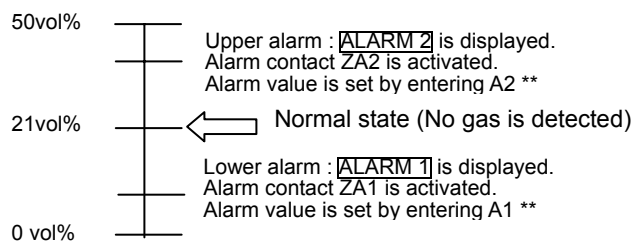

7-3 Trouble Alarm Operating Instructions

The trouble alarm will be activated in the following situations. (The open collector will be ON in normal mode, and OFF during trouble or when the power is disconnected.) The TROUBLE lamp (yellow) will blink, and analog output will drop to below 0.6 mA. When the problem is remedied, the trouble alarm will automatically return to normal.

(1) Decrease in the rate of flow

When the flow is not at the designated rate, it is assumed that it is decreasing.

FLOW is displayed on the LCD screen, and the flow rate rotation stops. Causes for a decrease in flow rate can include the clogging of filter elements, the clogging of pipes, the load being too high, deterioration of the pumps, etc.

(2) Sensor trouble

SENS. will be displayed on the LCD screen in the following situations:

- When the base output of the sensor unit has decreased significantly
- When the sensor has been disconnected. (For combustible gas sensor unit: CHS-7.)

(3) When a sensor unit has been inserted wrong

The settings, full scale values, and target gases to be detected are recorded in a detector after its first use. When a sensor unit with different settings information is inserted, this is determined to have been inserted wrong, and **SENS.** is displayed on the LCD screen. The concentration of the detected gases is displayed as: "----"

(4) Disconnection of the pyrolyzer

When the pyrolyzer has been disconnected after used, **CONV.** is displayed on the LCD screen.

(5) Disconnection of the power source

When the power source has been cut, all lamps (green, yellow, and red) will turn off, and all operations will cease.

(6) A blown fuse

When a fuse has blown or is disconnected, the power source becomes cut, and all lamps (green, yellow, and red) will turn off, and all operations will cease

Note

When the trouble alarm is activated while using the oxygen sensor unit COS-7, the analog output is reduced to less than 0.6 mA. When the host system setting is the lower limit alarm, trouble will occur if the analog output from the main unit drops to less than 0.6 mA within one second from the time that the lower limit alarm is *not* activated. To avoid this, set it so that the lower alarm limit is not activated.

○ : On △ : Blinking ● : Off

	Type of trouble	LCD display	POWER Lamp (green)	TROUBLE Lamp (yellow)	ALARM Lamp (red)	Remarks
1	Decrease in rate of flow	FLOW	○	△	●	The flow rate rotation is stopped
2	Sensor trouble	SENS.	○	△	●	
3	Incorrect insertion of the sensor unit	SENS.	○	△	●	The gas concentration display shows "----"
4	Pyrolyzer failure	CONV.	○	△	●	
5	Disconnection of the power source	(Nothing)	●	●	●	
6	Blown fuse	(Nothing)	●	●	●	

7-4 Test Mode Settings and Operating Instructions

(1) Settings

Press the “TEST” key switch on the front of the main unit.

When this is pressed once, it will go into test mode. When it is pressed again, it will return to normal mode.

*Test mode will automatically be released after 10 minutes.



Can be set with the UP/DOWN keys.

Press with the stick for test.
When pressed once, it will go into
test mode, when pressed again it
will return to normal.

(2) Operating Instructions

TEST is displayed on the LCD screen.

In test mode, the value of the analog output (4-20 mA) can be set to units of 0.16 mA (1% units of the full scale value).

The value of the analog output can be changed using the “UP/DOWN” keys.

Caution

The alarm check conducted with the test switch will also activate the gas alarm contacts. For this reason, if alarm contacts are used for interlocking with external devices, verify that the interlock be released prior to conducting the alarm test.

Be sure to conduct alarm testing after changing settings in either maintenance mode. (Refer to 7-5 *Maintenance Mode Settings and Operating Instructions*.)

Also, conduct inspections on the gas detection devices only after informing those involved.

7-5 Maintenance Mode Settings and Operating Instructions

(1) Settings

There are two types of maintenance modes. (See the table below for the functions of each.)

Set the maintenance switch at the bottom of the front of the main unit to 1 (left), or 2 (right).

Either MNT1 or MNT2 will be displayed on the LCD screen.

Move the maintenance switch to the center position to return to normal mode.

Set to maintenance mode.

Left: Maintenance mode 1

Center: Normal mode

Right: Maintenance mode 2

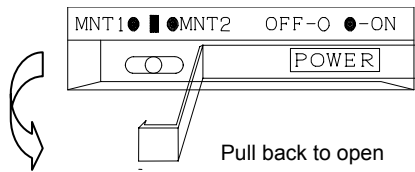

(2) Operating instructions

When on maintenance mode 1, neither the gas alarm contacts, nor the trouble alarm are activated.

When on maintenance mode 2, neither the gas alarm contacts, nor the trouble alarm are activated. And the analog output will be fixed to either 4.0 mA or 17.4 mA.

In both maintenance modes, the trouble lamp (yellow) blinks, and the concentration value of detected gas is displayed on the LCD screen.

	Alarm contacts	Trouble alarm	Analog output	TROUBLE Lamp (yellow)	LCD screen
Maintenance mode 1	Not activated (Fixed OFF)	Not activated *(Fixed ON)	Output based on the concentration value of the detected gas	Blinks	Concentration value of detected gas
Maintenance mode 2	Not activated (Fixed OFF)	Not activated *(Fixed to ON)	Fixed to 4mA or 17.4 mA.	Blinks	Concentration value of detected gas

⚠ Caution

*1 In both maintenance mode, the trouble alarm is activated when the power source is switched off on the main unit. (Trouble alarm : OFF)

*2 The analog signal may change when the power source is switched off on the main unit.

⚠ Warning

Be sure to check that it is set to normal mode (center) during regular operations (monitoring gas concentration.) When regular operations are carried out in maintenance modes 1 or 2, the alarm contacts and trouble alarms will not work. In maintenance mode 2, the analog signal will not change from 4 mA.

Note Both maintenance modes 1 and 2 function only on the base unit. Even when there is no main unit, analog output of 4mA is possible on maintenance mode 2, which enables a loop check during setup.

8 Maintenance and Inspection

- The Gas Detector unit does not normally require gas calibration to be performed on site. Gas calibration is performed by New Cosmos, so the user is only required to replace the sensor unit every six months. (This does not apply to the CHS-7 Combustible Gas Sensor Unit.)
- The following table provides an inspection timetable for various components of the Gas Detector unit. Daily inspections refer to inspections that should be undertaken by the user everyday. Periodic inspections refer to inspections that should be performed every six or twelve months by either the user or an authorized representative of New Cosmos.

Important

Regular replacement of the sensor unit and other relevant components is vital for maintaining the reliability of the Gas Detector unit. Users can replace the sensor unit by themselves, or have it replaced at regular intervals by signing a contract with New Cosmos.

Frequency and Content of Inspections

Content of Inspection	When starting up or relocating	Periodic inspection		Daily inspection
		Every 6 months	Every 12 months	
(1) Gas concentration indicator inspection	○	○		○
(2) Sampling flow rate inspection	○	○		
(3) Inspection of airtight seal of internal assembly	○	○		
(4) Replacement of filter element		○		
(5) Pipe line inspection	○			
(6) Attachment and replacement of sensor unit	○	○		
(7) Loop inspection using Test switch			○	

(1) Gas concentration indicator inspection

Verify that the gas concentration value is indicated on the LCD screen and the unit is functioning normally.

- POWER lamp (green): On
- TROUBLE lamp (yellow): Off
- ALARM lamp (red): Off

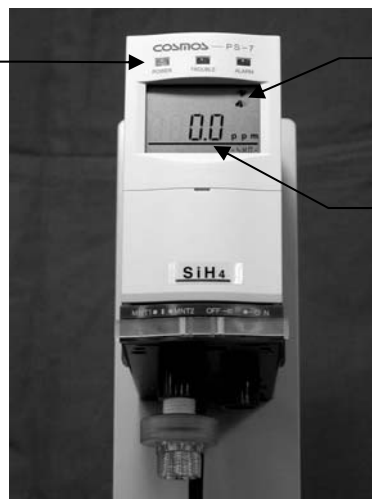

- Flow rate: Quick rotation
- Gas concentration (and units)

(2) Sampling flow rate inspection (Flow rate inspection)

Check that the flow rate on the LCD screen is rotating quickly. (Refer to *7-1 Operation Procedures (9)*). If the flow rate is rotating slowly or has stopped, check the filter element, and replace if clogged or dirty. (See *9-1 Replacing the Filter Element*.) If it still is not right after replacing the filter element, check to make sure the pipes are not clogged, or the load is not too high, etc.

(3) Inspection of airtight seal

Carry out an inspection of the airtightness of the internal assembly while referring to *7-1 Operation Procedures (10)*.



(4) Replacement of filter element

Check to ensure the filter elements are not clogged or dirty at least once every 6 months, and replace if necessary. Filter elements can get dirtier easier depending on the surrounding environment. When the display shows that the filter is clogged (the flow rate is on slow rotation), check the filter element and change if necessary. (Refer to *9-1 Replacing the Filter Element FE-1*.)

(5) Pipe inspection

Inspect the gas sampling pipe at startup or when the installation has been augmented or relocated. If the pipe is not correctly connected, it will not be possible to maintain the required sampling flow rate or to take gas samples from the target location.

(6) Attachment and replacement of sensor unit

Install a new sensor unit at startup and replace it every six months thereafter. (This does not apply to the CHS-7 Combustible Gas Sensor Unit.) (Refer to *9-2 Attach/Replacing the Sensor Unit* on page 29.)

(7) Loop inspection using Test switch

By pressing the “TEST” key switch on the front of the main unit with a long thin tip, such as that of a ball point pen, the analog output value can be set at will, so please check the host system. When “TEST” is pressed again, output returns to normal. (Refer to *7-4 Test Mode Settings and Operating Instructions*.)

 Caution

The alarm check conducted with the Test switch will also activate the gas alarm contact. For this reason, if alarm contacts are used for interlocking with external devices, be sure to check that the interlock be released prior to conducting the alarm test. Also, be sure to carry out alarm testing with the test switch after setting in maintenance mode. (Refer to *7-5 Maintenance Mode Settings and Operating Instructions*.)

Relevant personnel should also be notified of the inspection in advance.

9 Replacing Consumables

- The Gas Detector is designed to allow users to replace consumables.
- Contact your local dealer to purchase consumables, or if further instruction is needed regarding their installation and replacement.

9-1 Replacing the Filter Element (FE-1)

Use the following procedure to replace the filter element if it becomes dirty or clogged.



Loosen the fastening nut of the filter unit (MF-50) and remove the gas sampling pipe.

Rotation direction to loosen the fastening nut.

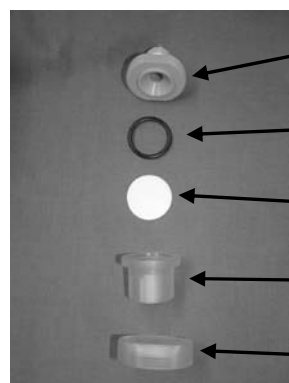

Main body side of the filter unit

O-ring

Replace with a new filter element (FE-1)

Suction hole in the filter unit

Fastening nut

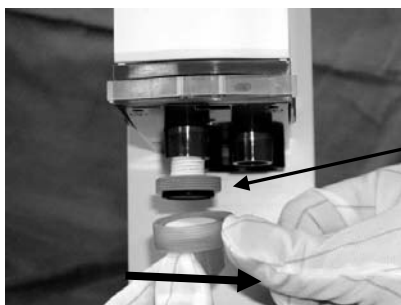

Don't forget the O-ring!

Rotation direction to tighten the fastening nut.

Return the filter unit gas intake to its original position and tighten the fastening nut to secure the gas sampling pipe. Do not forget to place the O-ring beneath the new filter. sam

9-2 Attach/Replacing the Sensor Unit

Warning

Verify that the detected gas type and the full-scale value of the new sensor unit are the same as the sensor unit being replaced. Be sure to check that its expiration date has not passed. (There is no expiration date displayed for the Combustible Gas Sensor Unit CHS-7.)

Caution

- The sensor unit must be replaced every six months. (This does not apply to the CHS-7 Combustible Gas Sensor Unit.) Always replace sensor units that have reached their service life.
- The shelf life of a new sensor unit is stated on its bag. The replacement sensor unit must be installed before the shelf life has expired.
- Turn off the power source before carrying out any replacements. However, when the power switch to the main unit is turned off to replace the sensor unit, the trouble alarm output (open collector) is also turned off. If alarm contacts are used for interlocking with external devices, verify that the interlock be released prior to conducting the alarm test.

1. Turn off the power source to the main unit

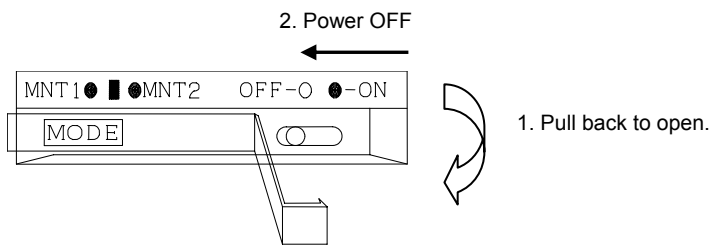

2. Pull both the two latches at the bottom of the base unit back, and (while they are still pulled back) release the main unit, pulling from the top.

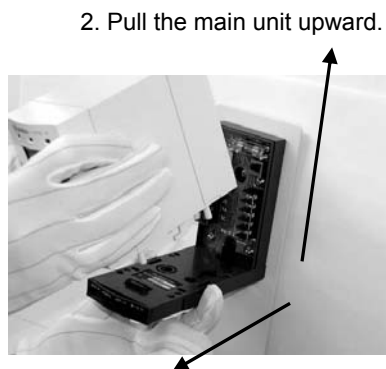

1. Pull the latch back.

3. Press back while pushing on the middle of the upper section of the main body cover with your thumb, and remove the cover.

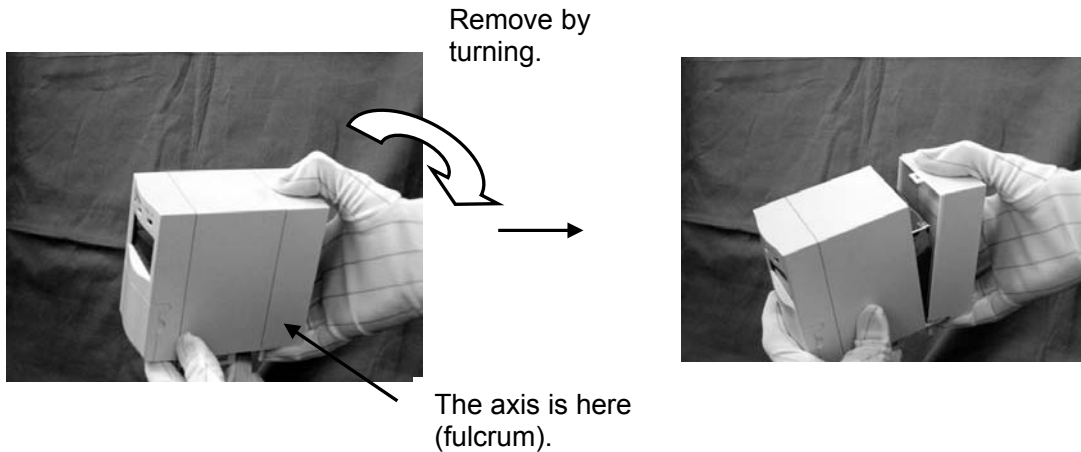

4. Insert a finger in the gap between the main body and the top of sensor unit, and pull back slightly. Then grasp the sides of the sensor unit, and pull out.

Insert a finger, and pull slightly

Pull out grasping the sides



5. Insert the new sensor unit, then reattach the main body cover.

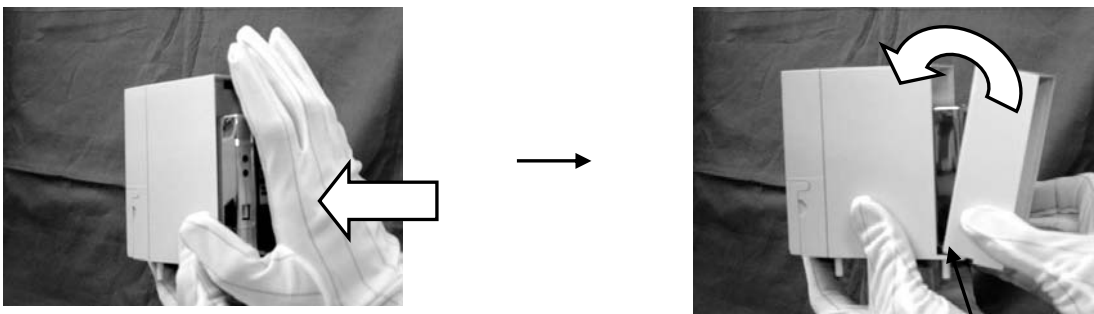

Push in as far as it will go with the palm of your hand.

The axis is here (fulcrum).

⚠ Warning

If the sensor unit is improperly attached, it will not be made airtight and will fail to detect gas correctly. Be sure to attach it in as far as it will go.

6. Pull back the latches on both the left and right sides of the bottom of the base unit, and attach the main unit inserting from the top side first.

2. Insert so that it slides along the rails.

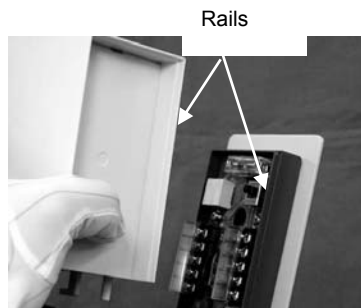

1. Pull back both latches

7. Push both the latches on the left and right hand sides of the base unit back in until the locked/unlocked line can be seen

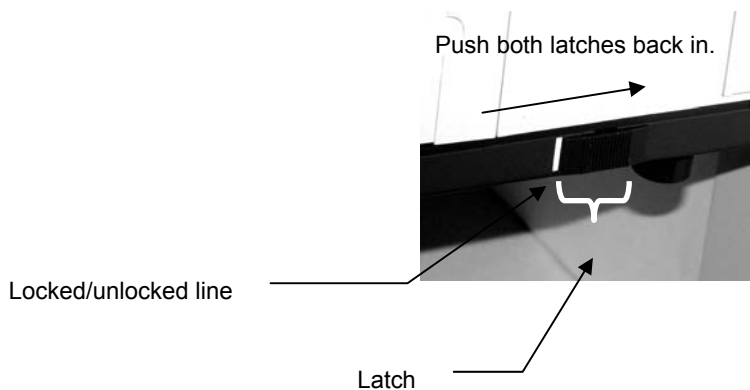

 **Warning**

Be sure to return the latches right back in. If the latches are not behind the locked/ unlocked line, gas detection will not work properly.

Note

Please return used sensor units to your authorized dealer.

9-3 Replacing the Sampling Unit

Caution

Always turn OFF the power supply before attempting to replace the sampling unit. However, if the power switch to the main unit is turned off to replace the sampling unit, the trouble alarm output (open collector) will also turn off. If alarm contacts are used for interlocking with external devices, verify that the interlock be released prior to replacing the unit.

1. Remove the sensor unit as described in 9-2 *Attach/Replacing the Sensor Unit*.
2. Press back while pushing on the lower section of the main body cover with both thumbs, and remove the front panel.

The position to push from

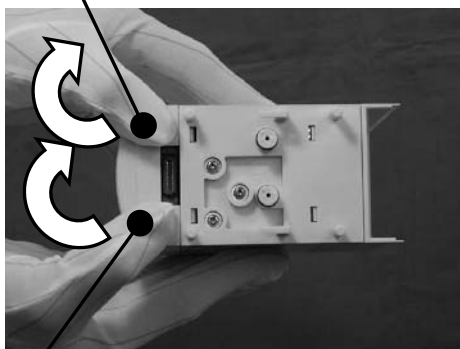

The position to push from. Push the lower section of the front panel with both thumbs and remove.

Direction to push with thumb

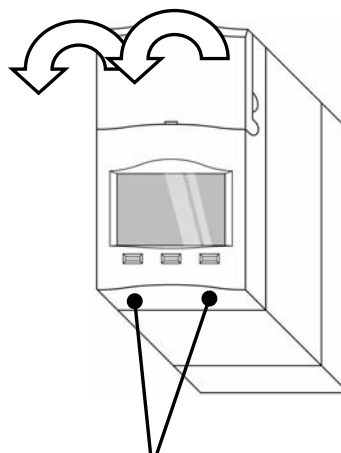

The axis is here (fulcrum).

3. Remove the two connectors on the back of the front panel.

Pull out the connectors on the pump side.

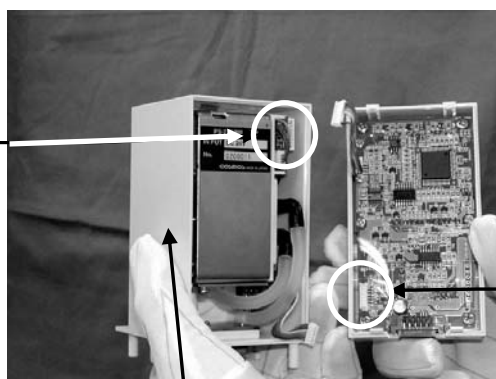

Pull out the connectors on the front panel.

Sampling unit

4. Connect the 2 front panel connectors to the new sampling unit, and reattach the front panel. After inserting the sensor unit, reattach the main body cover.

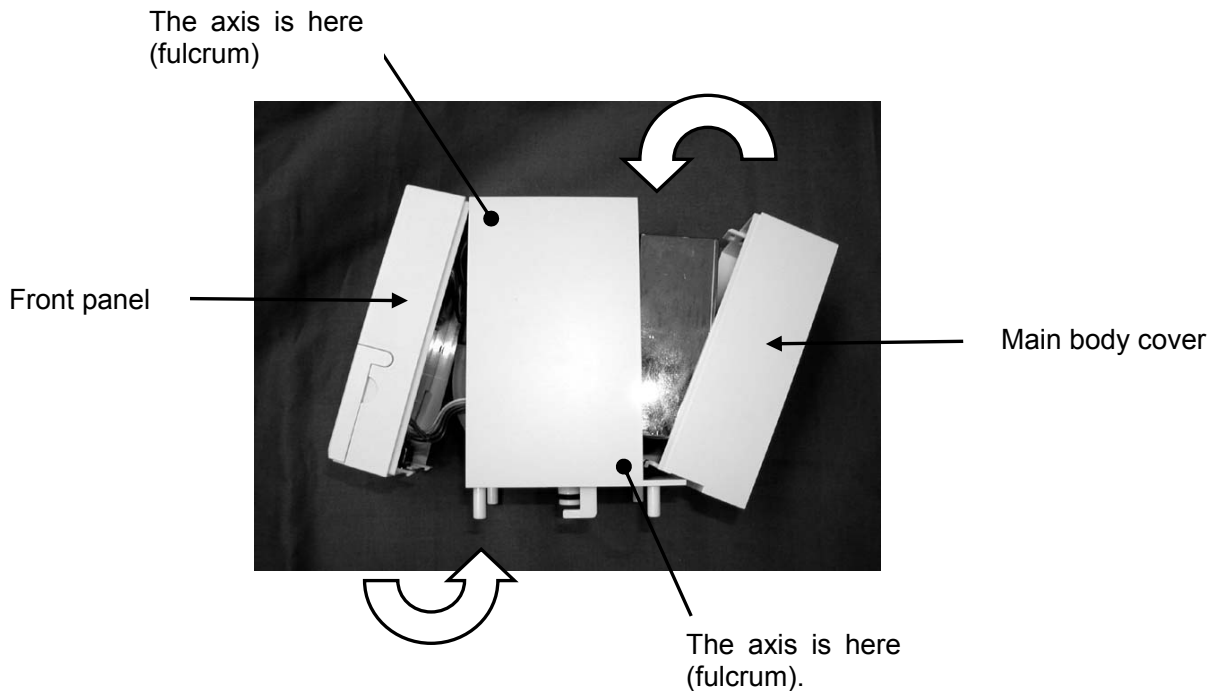

*Be careful not to pinch the cables.

Warning

If used when not inserted properly, the sensor unit will not be airtight, and will therefore not detect gases properly. Be sure to attach it on as far as it will go
Also, when connecting the sampling unit with the front panel, be careful that the connector cables are not pinched by the case.
Also, when attaching the front panel onto the sampling unit, be careful that the connector cables are not pinched by the case.

The following is the same as the procedure from step 6 onward in *9-2 Replacing the Sensor Unit*.

5. Pull back the latches on both the left and right sides of the bottom of the base unit, and attach the main unit inserting from the top side first.
6. Push both the latches on the left and right hand sides of the base unit back in until the locked/unlocked line can be seen

Note

Please return used sampling units back to your authorized dealer.

10 Troubleshooting

- If a problem occurs, check the following before contacting a service or sales representative.

Problem	Cause	Remedy	Reference
The POWER lamp (green) does not come on when the power is turned on	The power switch on the base unit is turned OFF.	Turn the power switch to the base unit ON.	7 Operation Procedures
	The power switch on the main unit is turned OFF.	Turn the power switch to the main unit ON.	7 Operation Procedures
	Wiring is not properly connected.	Check wiring and tighten terminal connections.	6-2 Wiring Instructions
	The connector harness is not connected properly.	Check and reattach the connector.	9-3 Replacing the Sampling Unit
	The fuse has blown.	Replace the fuse.	5 Description
The TROUBLE lamp (yellow) is blinking	The filter element is clogged.	Replace the filter element.	9-1 Replacing the Filter Element FE-1
	Pump is defective.	Replace the pump unit.	9-3 Replacing the Sampling Unit
	Gas sampling pipe is blocked.	Remove the blockage.	
	The connector harness is not connected properly.	Check and reattach the connector.	9-3 Replacing the Sampling Unit
	A sensor with different setting has been inserted.	Change the settings on the main unit, or change the sensor.	7-1 Operation Procedures
	Defective sensor unit.	Replace the sensor unit.	9-2 Attach/Replacing the Sensor Unit
	Sensor unit is not installed.	Install the sensor unit.	9-2 Attach/Replacing the Sensor Unit
	The output of the flow sensor was not stable when power was turned on.	Turn the power on, and leave for about 30 minutes until it stabilizes.	7-1 Operation Procedures
The “ <u> </u> ” indication and the detected gas concentration value blink alternately.	It is set to either maintenance mode 1 or 2.	Set to normal mode (center).	7-5 Maintenance Mode Settings and Operating Instructions
There is no electrical output from the alarm contacts.	It is set to either maintenance mode 1 or 2.	Set to normal mode (center).	7-5 Maintenance Mode Settings and Operating Instructions
	Wiring is not properly connected.	Check wiring and tighten terminal connections.	6-2 Wiring Instructions
The analog output won't change from 4mA.	The maintenance switch is set to 2.	Set to normal mode (center).	7-5 Maintenance Mode Settings and Operating Instructions

Contact your local dealer if none of the above procedures remedy the problem or if the problem is not listed.

11 Specifications

Model	PS-7
Principle	Electrochemical sensor, hot-wire semiconductor sensor, galvanic cell sensor
Sampling method	Pump suction type (0.5 L/min, suction flow automatically controlled)
Gas sampling pipe* ¹	Teflon ¼" OD 3/16" ID, maximum tube length 15-30 m.
Concentration display	4-digit digital LCD display (incl. units) 20-segment bar graph
Alarm settings	As per specifications
Alarm accuracy	<ul style="list-style-type: none"> • Combustible gas ±25% of preset alarm point under identical conditions • Toxic gas ±30% of preset alarm point under identical conditions • Oxygen deficiency ±1 vol% under identical conditions
Response time	<ul style="list-style-type: none"> • Combustible gas Within 30 sec using test gas concentration 1.6 times that of preset alarm point • Toxic gas Within 60 sec. using test gas concentration 1.6 times that of preset alarm point • Oxygen deficiency Within 5 sec. to reach 18 vol% reading (at 20 ±2°C) from an atmosphere concentration of 10 vol% <p>(Gas sampling pipe length and communication times not included in any of the above.)</p>
Alarm display	<ul style="list-style-type: none"> • Gas alarm (1st and 2nd stage) ALARM lamp (red) blinking: LCD display ALARM1 or ALARM2 is displayed • Trouble alarm Decreased rate of flow TROUBLE lamp (yellow): LCD display FLOW displayed : The flow rate rotation is stopped Sensor trouble TROUBLE lamp (yellow) blinking: LCD display SENS. is displayed The sensor unit is inserted incorrectly TROUBLE lamp (yellow): LCD screen SENS. is displayed Pyrolyzer is disconnected TROUBLE lamp (yellow) blinking: LCD screen CONV. is displayed
External output	<ul style="list-style-type: none"> • Analog output 4-20mA DC (common negative with power supply) *Resistance for detecting current to be less than 300Ω including circuit resistance. • Alarm contacts (1st and 2nd stages) 1a no-voltage contact/auto reset *Rated load: 125 V AC or 30 V DC, 0.5-A resistance load • Trouble alarm Open collector/auto return/auto reset (Normal close: Normally ON, during trouble OFF, and OFF during shut-off of power supply.) *Rated load: 30 V DC, 30mA resistance load Activated by decline of flow rate, sensor error, when the sensor unit has been inserted incorrectly, pyrolyzer is disconnected, power off, or blown fuse. The analog output is smaller than 0.6 mA, and the gas alarm is not activated.
Applicable cable	Shielded control cable (8 to 11 mm dia.) x2
Cable length	Maximum length not exceeding 500 m
Operating Temp	0-40°C (avoid radical temperature fluctuation), 30-85% RH (no dew condensation)
Power requirement	24 V DC ±10%
Power consumption	Approximately 7 W (Approximately 10 W with convertor attached)
Dimensions	W62 × H124 × D143 mm (projected portion excluded)
Weight	Approximately 1.0 kg
Installation	Wall mount type

*1 Teflon tubing is recommended. However, this may differ if the unit is to be used to detect highly adsorbent gases. Contact your authorized dealer for information and assistance.

For product improvement purposes, the above specifications may be subject to change without notice. Any specifications issued separately take precedence over those stated above.

12 Warranty

New Cosmos Electric Company Limited, warrants its gas detection products against any defects in materials and workmanship under normal use and operating conditions, for a period of one year from the date of purchase.

(Except toxic and oxygen sensor unit)

All obligations and liabilities under this product warranty are limited to repairing or replacing at the manufacturer's option of the allegedly defective items returned to us, with carrier charges prepaid. All repairs and replacements are made subject to our factory inspection of the returned items.

No liability is accepted for the consequential damages or reinstallation labor. Defects as defined in the above shall not include decomposition by chemical reaction (including corrosion).

New Cosmos Electric Company Limited, shall not assume responsibility for contingent liability arising from alleged failure of any of its products and accessories.

13 Detection Principles

13-1 Electrochemical Sensor

In an electrochemical method, electrolytic reactions are carried out selectively on target composite gases, and the ensuing electrolytic current is measured by a gas sensor.

The gas sensor consists of three electrodes (active, reference, and counter electrodes), electrolyte, and a potentiostat circuit. The electrode is a gas permeable membrane (to permeate gas and not electrolyte) treated with a catalyst. When SiH_4 contacts the active electrode, the following reaction occurs on the electrode:

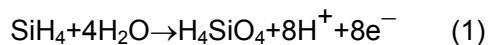

while the following reaction occurs on the counter electrode:

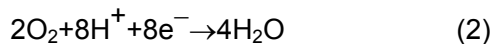

and current flows to the external circuit. To make the reaction selective and the generated current proportional to the concentration of SiH_4 , the potential of the active electrode is detected by the reference electrode and, during the electrolysis reaction, the active electrode is maintained at a constant potential by the potentiostat circuit.

(Refer to the following illustration.)

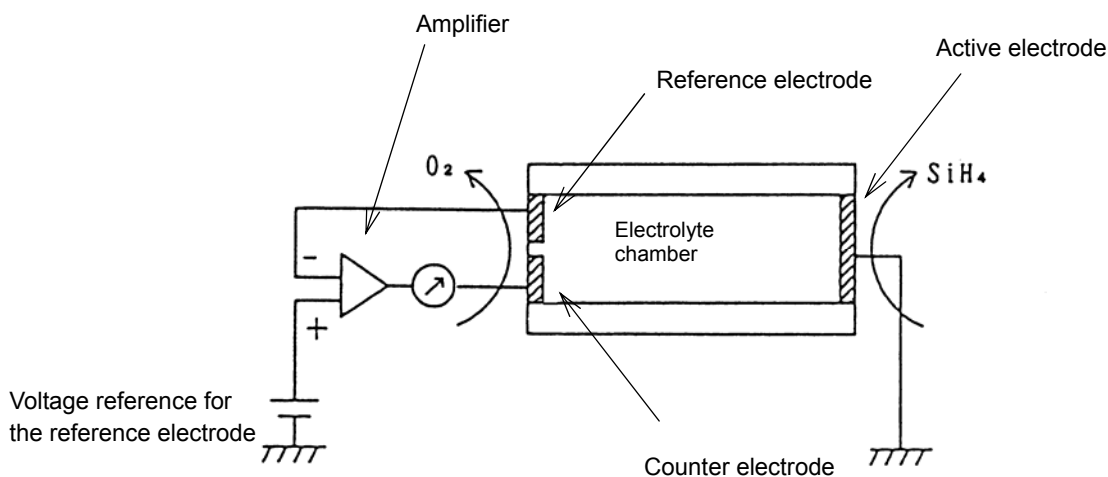

13-2 Hot-wire Semiconductor Sensor

In the hot-wire semiconductor method, a semiconductor sensor is designed to measure the change of electrical conductivity initiated by adsorption of the electrons of combustible gases onto the surface of a metal oxide semiconductor heated with a platinum filament. When the semiconductor adsorbs these electrons, the electron concentration increases and the conductivity of the semiconductor rises. As a result, the temperature of the semiconductor declines, and the resistance of the platinum filament decreases. This change is measured as a deviation voltage with a Wheatstone bridge.

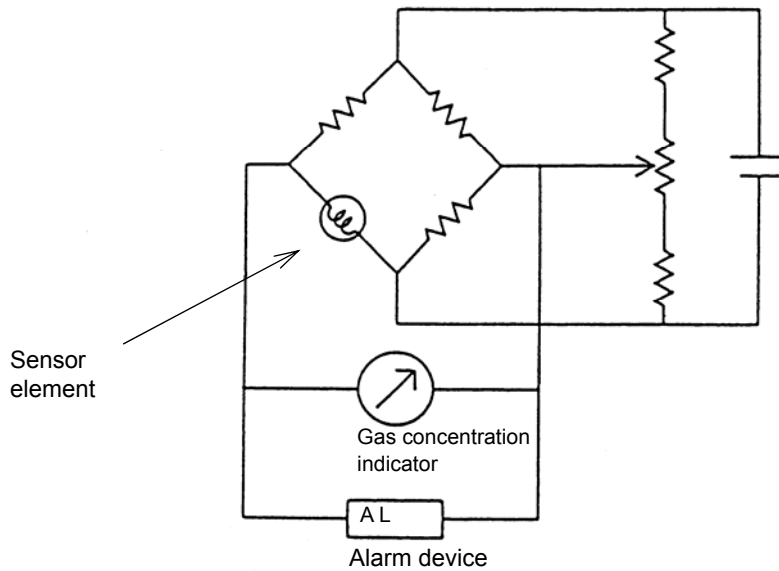
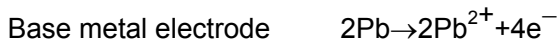
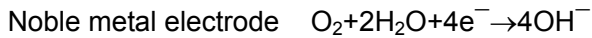

Figure 9

13-3 Galvanic Cell Sensor

The galvanic cell sensor consists of noble metal (Pt, Ag) electrode, a base metal (Pb) electrode, and electrolyte. The noble metal electrode contacts the air through a Teflon membrane.

Since a potential difference is produced between the two electrodes, the following reaction occurs when a load resistor is connected:



As a result, a current proportional to the concentration of oxygen in the air flows from the noble metal electrode to the base metal electrode through an external circuit. Since the current generated is dependent on temperature, a thermistor is used to compensate for the atmospheric temperature changes.

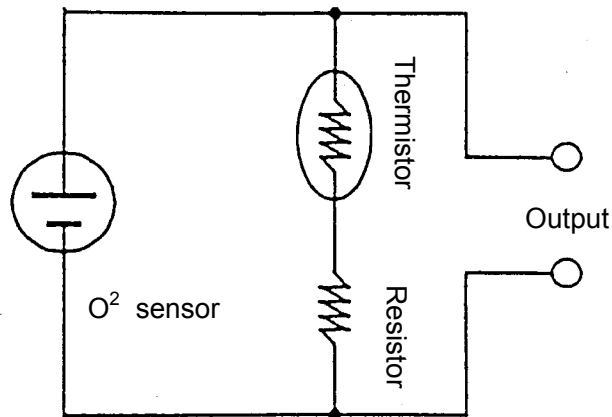

Figure 10

Note

The galvanic cell sensor gives an output according to the partial pressure of the oxygen in the air (the oxygen concentration is usually 21vol%.) Therefore, when the atmospheric pressure changes, the partial pressure of the oxygen will change, and when there is no change in the oxygen concentration (21vol%), this may effect the output values from the sensor.

14 Glossary

Gas detector:	Detects the gas concentration level, and converts it into an electric signal.
Target gases for detection:	The target gases for which the gas concentration level is detected, and indications or warnings are given.
Detection range:	The concentration range within which the level of target gases can be detected, and indications or warnings given.
Alarm delay:	The time between when a level of gas concentration higher (or lower) than the preset alarm values come into contact with the gas detector, and when the alarm goes off.
Explosion-proof construction:	Construction to ensure that electrical components do not become an ignition source and do not ignite surrounding flammable air.
Maintenance inspection:	Inspections conducted to ensure that the instrument is able to continue carrying out the functions demanded of it.

Part of this terminology list is quoted from gas detection monitor terminology definitions from the Industrial Gas Detectors Monitor Association.

Manual Revision History

Edition No.	Date	Revisions
GAE-018-00	August 2004	

Additional copies of this Operation Manual are available.

Contact the following address for ordering information.

Manufacturer:

New Cosmos Electric Co., Ltd.

2-5-4 Mitsuya-naka

Yodogawa-ku

Osaka 532-0036, Japan

Phone 81-6-6309-1505

Fax 81-6-6309-1514

Distributor:

DOD Technologies, Inc

740 McArdle Drive

Unit C

Crystal Lake, IL 60014

Phone 815-788-5200

Fax 815-788-5200

www.dodtec.com